



look
no wires...
just total
control



OPTIDRIVE™

a global revolution in drives...

wireless control for
hundreds of applications



Invertek Drives Ltd are dedicated to the design, manufacture and marketing of electronic variable speed drives for controlling electric motors.

The state of the art UK headquarters houses specialist facilities for research & development, manufacturing and global marketing. All operations, including research and development, are accredited to the exacting customer focussed ISO 9001:2000 quality standard.

The Company's products are sold globally by a network of specialist distributors in over 40 different countries. Invertek Drives unique and innovative Optidrive range is designed for ease of use and installation and meets with recognised international design standards for CE (Europe), UL (USA) and CTick (Australia).



with Invertek Drives
the revolution starts here!

- easy to use and incredible performance
- leading edge design and technology
- highly committed to innovation
- wireless control for hundreds of applications
- products you can rely on
- global support and suppliers

OPTIDRIVE... puts you in total control

OPTIDRIVE PLUS 3^{GV}

3rd Generation Vector Control

AC Variable Speed Drive 0.37-160kW

Optidrive Plus 3^{GV} is the natural evolution of the Optidrive family adding ultimate motor control to established Optidrive benchmarks of control and ease of use.

Optidrive Plus 3^{GV} uses 3^{GV} technology, a revolutionary and patented motor control strategy. 3^{GV} technology delivers 100% torque at 0.0Hz allowing this unique open loop product to be used without any feedback device in many traditional closed loop applications.

Only the motor name plate data is required to achieve optimum performance, the drive continuously and automatically determines and tracks the key motor characteristics required for vector control.

Optidrive Plus 3^{GV} can be commissioned using the unique Optiwand CE Plus software designed for use on pocket pc's. Communication takes place without wires using infrared light to quickly and accurately transfer data.

Key Benefits

- True evolution of range, maintaining same footprint and connector arrangement as original
- Fast and accurate parameter configuration using unique Optiwand CE Plus and Optistore Plus
- Small mechanical envelope
- Rugged industrial operation 50°C ambient rating
- Simple mechanical & electrical installation
- Simple operation, powerful features & easy to use
- Fast setup, 14 basic parameters
- Real time motor current, motor speed and kW indication
- Debugging using troubleshooting & P0
- 150% overload for 60 secs (175% for 2 secs)
- Keypad control
- Spin start
- **100% torque at 0.0Hz (no encoder)**
- Built in PID controller for feedback control systems
- Speed regulation <1%
- Torque control
- Dual high speed serial communication interfaces
 - Optical (IrDA) interface for commissioning and low bandwidth control systems (115kbps)
 - RS485/ Modbus RTU interface for high bandwidth control (9k6 to 115kbps)



Key Physical Features

- Pluggable control terminals
- Easy access key slots for simple installation
- Easy access contactor style power terminals for intuitive easy wiring
- Help card for basic parameter description and terminal layout
- Easy to use keypad with bright LED display
- IP20
- Integral rfi filter
- Integral braking transistor (not size 1)
- 3 phase line choke (size 4, 5 & 6)

Key Control I/O Features

- Programmable I/O for flexible control
- 12 bit bipolar analogue input, 8ms sample time
- 2nd analogue input for PID feedback control systems
- Positive logic digital inputs (active high), 8ms sampling
- 24V/ 100mA user supply output
- 0..10V & 4..20mA analog output, 8ms update
- Galvanically isolated and short circuit proof

Key Programming Features

- Silent motor running with 32kHz ultra-quiet switching
- 8 preset speeds
- Mains dip ride through
- Skip frequency
- Last 4 trips stored
- 2kHz output frequency
- Parameter lock
- Hours run & kWh meters
- Speed scaling factor for master- slave arrangements
- 2nd deceleration ramp for rapid stop
- Display scaling to show real values ie "bottles/ hour"

A Revolution Evolution – 21st Century Motor Control

Optidrive Plus 3^{GV}'s revolutionary and patented 3^{GV} (3rd Generation Vector) vector control strategy provides smooth, controlled full torque through zero speed in open loop mode, without the need for motor tacho-generators or encoders.

The 3^{GV} ultrafast torque control ensures it is the ideal drive for applications across the industrial spectrum. **Fast** enough for pulse loads like jogging machines and industrial washers. **Powerful** enough for high starting torque applications like crushers and fully loaded conveyors. **Smooth** enough for hoists and cranes.

Only motor nameplate details are required to achieve optimum performance. Optidrive Plus 3^{GV} automatically performs an automatic tuning routine measuring vital motor inductances, resistances, currents and power factor with the motor at standstill. After the initial tuning, these values are constantly adapted in real time to ensure that performance is maintained irrespective of changes arising out of motor heating.

Non linearities are further corrected using highly sophisticated measurement and compensation techniques to give a very high quality sine wave output. This results in smooth operation from zero up to **2kHz** output frequency, without discontinuity and making this range of products ideal for high speed applications such as machine tool spindles.

**Torque vs Motor Frequency (Log Scale)
Showing Full Torque Across The Speed Range**

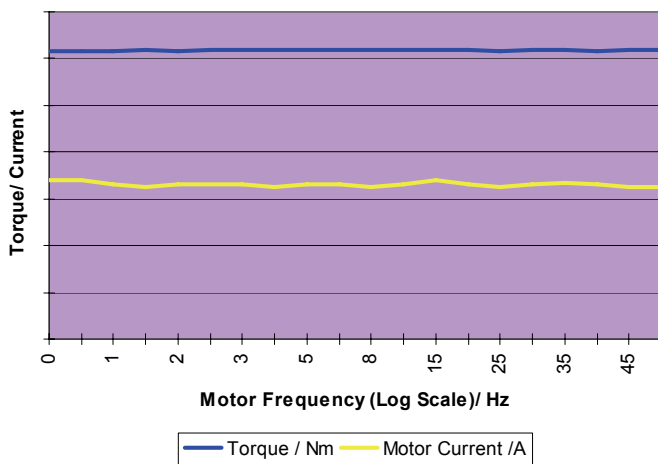

Ultra-smooth high frequency current waveform, ideal for machine tool spindle applications

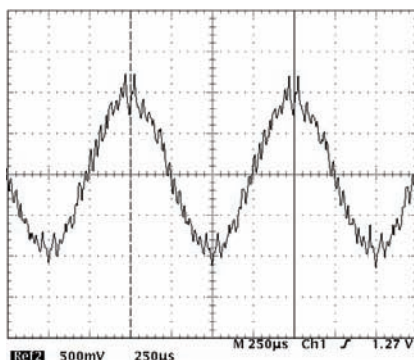

4 easy steps to *Incredible Performance*

Step 1

Connect motor to drive (check star/ delta connection) & apply power to drive

Step 2

Input motor data from motor name plate:

*P1-07 motor rated voltage
P1-08 motor rated current
P1-09 motor rated frequency*

Step 3

Change mode to 3GV,
P4-01 = 0

Step 4

Autotune, *P4-02 = 1*

.....drive performs a static automatic tuning routine, after which motor performance is optimised for dynamic response, energy saving and maximum torque

ELECTRICAL DATA

OPTIDRIVE P SIZE 1

Model	ODP -xxxx-IN	12037	12075	12150
Motor output rating	kW	0.37	0.75	1.5
Model	ODP -xxxx-USA	12005	12010	12020
Motor output rating	HP	0.5	1.0	2.0
Supply voltage/ phases	V +/- 10%	220-240/ 1Ø		
Supply fuse or MCB rating	A	6-10	10	20
Output voltage/ phases	V	0-240V/ 3Ø		
Output current	A	2.3	4.3	7.0
Max motor cable length	m	25		

OPTIDRIVE P SIZE 2

Model	ODP -xxxx-IN	22150	22220	24075	24150	24220	24400
Motor output rating	kW	1.5	2.2	0.75	1.5	2.2	4
Model	ODP -xxxx-USA	22020	22030	24010	24020	24030	24050
Motor output rating	HP	2.0	3.0	1.0	2.0	3.0	5.0
Supply voltage/ phases	V +/- 10%	220-240/ 1Ø			380-480/ 3Ø		
Supply fuse or MCB rating	A	20	30	6-10	10	10	20
Output voltage/ phases	V	0-240/ 3Ø			0-480/ 3Ø		
Output current	A	7	10.5	2.2	4.1	5.8	9.5
Max motor cable length	m	100	100	50	100	100	100
Min brake resistor	Ω	33	22	47	47	47	33

OPTIDRIVE P SIZE 3

Model	ODP -xxxx-IN	32030	32040	32055	34055	34075	34110	34150
Motor output rating - industrial 150% o/l	kW	3.0	4.0	5.5	5.5	7.5	11.0	15.0
Model	ODP -xxxx-USA	32040	32050	32075	34075	34100	34150	34200
Motor output rating - industrial 150% o/l	HP	4	5	7.5	7.5	10.0	15.0	20.0
Supply voltage/ phases	V +/- 10%	220-240/ 1 (50% derating) or 3Ø			380-480/ 3Ø			
Supply fuse or MCB rating	A	32	32	50	32	32	50	50
Output voltage/ phases	V	0-240/ 3Ø			0-480/ 3Ø			
Output Amps - industrial 150% overload	A	14	18	25	14	18	25	30
Max motor cable length	m	100						
Min brake resistor	Ω	15			22			

OPTIDRIVE P SIZE 4

Model	ODP -xxxx-IN	42075	42110	42150	42185	44185	44220	44300	44370
Motor output rating - industrial 150% o/l	kW	7.5	11	15	18.5	18.5	22	30	37
Model	ODP -xxxx-USA	42100	42150	42200	42250	44250	44300	44400	44500
Motor output rating - industrial 150% o/l	HP	10	15	20	25	25	30	40	50
Supply voltage/ phases	V +/- 10%	220-240/ 1 (50% derating) or 3Ø				380-480/ 3Ø			
Supply fuse or MCB rating	A	80	80-100	100	100-125	80	80-100	100	100-125
Output voltage/ phases	V	0-240/ 3Ø				0-480/ 3Ø			
Output Amps - industrial 150% overload	A	39	46	61	72	39	46	61	72
Max motor cable length	m	100							
Min brake resistor	Ω	6				12			

OPTIDRIVE P SIZE 5

Model	ODP -xxxx-IN	52220	52300	52370	52450	54450	54550	54750	54900
Motor output rating - industrial 150% o/l	kW	22	30	37	45	45	55	75	90
Model	ODP -xxxx-USA	52300	52400	52500	52600	54600	54750	54100	54120
Motor output rating - industrial 150% o/l	HP	30	40	50	60	60	75	100	120
Supply voltage/ phases	V +/- 10%	220-240/ 1 (50% derating) or 3Ø				380-480/ 3Ø			
Supply fuse or MCB rating	A	160	200	250-300	250-300	160	200	250-300	250-300
Output voltage/ phases	V	0-240/ 3Ø				0-480/ 3Ø			
Output Amps - industrial 150% overload	A	90	110	150	180	90	110	150	180
Max motor cable length	m	100							
Min brake resistor	Ω	3				6			

OPTIDRIVE P SIZE 6

Model	ODP -xxxx-IN	62055	62075	62090	64110	64132	64160
Motor output rating - industrial 150% o/l	kW	55	75	90	110	132	160
Model	ODP -xxxx-USA	62750	62100	62120	64150	64175	64210
Motor output rating - industrial 150% o/l	HP	75	100	120	150	175	250
Supply voltage/ phases	V +/- 10%	220-240/ 1 (50% derating) or 3Ø				380-480/ 3Ø	
Supply fuse or MCB rating	A	315-350	400	450-500	315-350	400	450-500
Output voltage/ phases	V	0-240/ 3Ø				0-480/ 3Ø	
Output Amps - industrial 150% overload	A	202	240	300	202	240	300
Max motor cable length	m	100					
Min brake resistor	Ω	3				6	

SPECIFICATION

- Supply frequency 48 to 62 Hz
- Max. permissible 3-phase supply imbalance 3%
- Max. ambient temperature 50 °C
- Max. altitude 2000 m
- Derate above 1000 m, 1% / 100 m
- For higher switching frequencies, derate output current 5%/°C above max. ambient up to 50°C
- I x t protection above 100% output current
- 150% overload protection for 60 sec
- 175% overload allowable for 2 sec
- Storage temperature -40 to +60 °C
- Options:
 - Optiwand CE Plus & Optistore Plus
 - Optiport Plus
 - RS485 data cables and accessories
 - Optilink
 - Gateway options
 - 3ROUT (3 Relay Output)
 - Isolated USB to RS485 adaptor
 - Optifilter
 - Optibrake
 - Input Chokes
 - Output Filters

CONTROL TERMINAL ARRANGEMENT

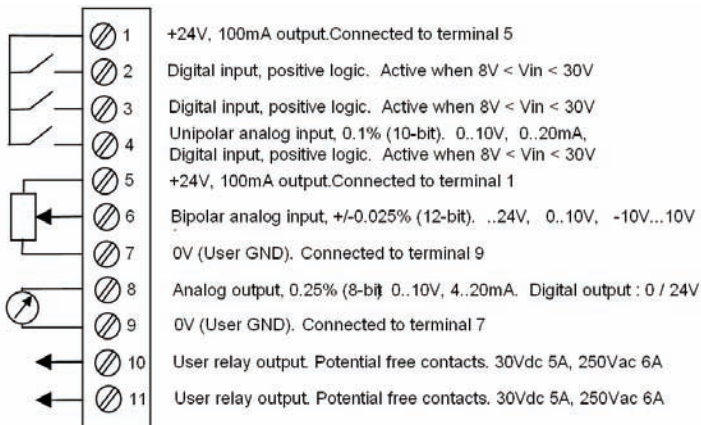

COMMUNICATION INTERFACE

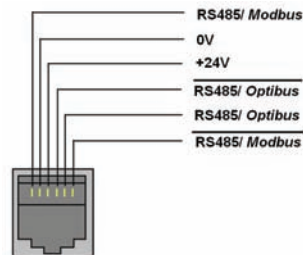

OPTIDRIVE DIMENSIONS

	Size 1	Size 2	Size 3	Size 4	Size 5 *	Size 5 **	Size 6
Length / mm	155	260	260	520	1045	1100	1100
Width / mm	80	100	171	340	340	340	340
Depth / mm	130	175	175	220	220	330	330
Weight/ kg	1.1	2.6	5.3	28	67	68	55 ***
Fixings	2 * M4		4 * M4	4 * M8			
Power Terminal torque settings	1 Nm			4 Nm	8 Nm		

* Size 5 – 90A and 110A ratings

** Size 5 – 150A and 180A ratings

*** Size 6 has external line choke weighing 27kg

ENCLOSURE - NON VENTED DIMENSIONS (mm)

DRIVE POWER RATING	SEALED UNIT		
	W	H	D
Size 1 0.75kW 200V	250	300	200
Size 1 1.5kW 200V	300	400	250
Size 2 1.5kW 200V / 2.2kW 400V	300	400	300
Size 2 2.2kW 200V / 4kW 400V	450	600	300

ENCLOSURE – VENTED DIMENSIONS (mm)

DRIVE POWER RATING	VENTED UNIT			FORCE VENTED (WITH FAN)			
	W	H	D	W	H	D	Air Flow
Size 1 (1.5kW)	300	400	150	200	300	150	> 15m ³ / h
Size 2 (4kW)	400	600	250	300	400	250	> 45m ³ / h
Size 3 (15kW)	600	800	300	400	600	250	> 80m ³ / h
Size 4 (22kW)	600	1000	300	600	800	300	> 300m ³ / h
Size 4 (37kW)	N/A	N/A	N/A	600	800	300	> 300m ³ / h
Size 5 (90kW)	N/A	N/A	N/A	800	1600	400	> 900m ³ / h
Size 6 (160kW)	N/A	N/A	N/A	800	2000	400	> 1000m ³ / h

Size 5 & 6



Size 4



Communication Interfaces

	Interface	Protocol	Baud (bps)	Purpose	Connections
RS485	RS485	Modbus RTU	9k6 – 115k	High bandwidth control systems	<ul style="list-style-type: none"> • Drive to plc • Drive to fieldbus gateway
		Optibus Plus	115k	Low bandwidth control systems	<ul style="list-style-type: none"> • Drive to pc (Optistore) • Drive to drive (unlimited slaves)
Optical	IrdA	Optibus Plus	115k	Small, low bandwidth control systems	Drive to drive (max. 2 slaves)
				Commissioning	Commissioning

Master – Slave/ Drive to Drive Communication

Master – slave networks can be easily created by connecting the communication ports. Optiwand CE Plus can be used for commissioning individual drives through the optical port even when the drives are connected in an RS485 network.

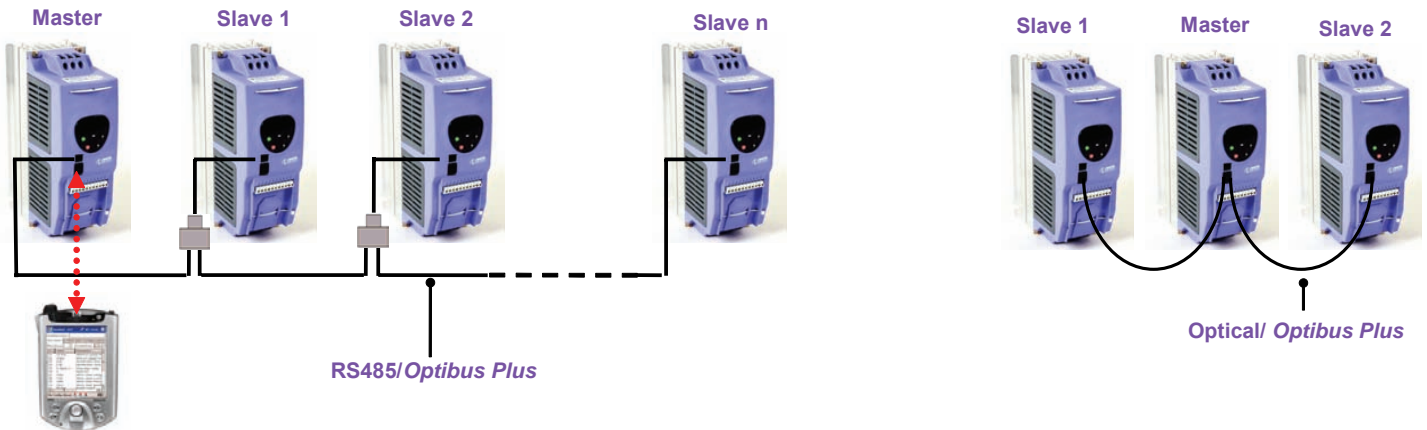

Drive Networks to Intelligent Controllers

High bandwidth control systems can be created for up to 63 drives connected to an intelligent network with RS485/ Modbus RTU. Optiport Plus and/ or Optistore Plus can run on the same network using an RS485/ Optibus Plus connection for monitoring purposes, but not for control.

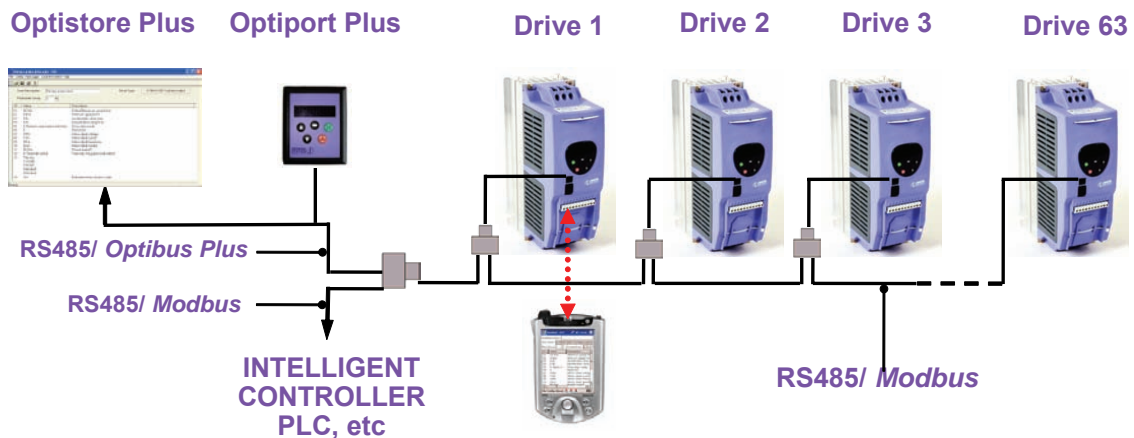

Fieldbus Communication

Optidrive Plus 3^{GV} connects to high speed communication networks via a gateway.

1 DeviceNet gateway can connect with up to 4 Optidrive.

1 Profibus gateway can connect with up to 8 Optidrive.

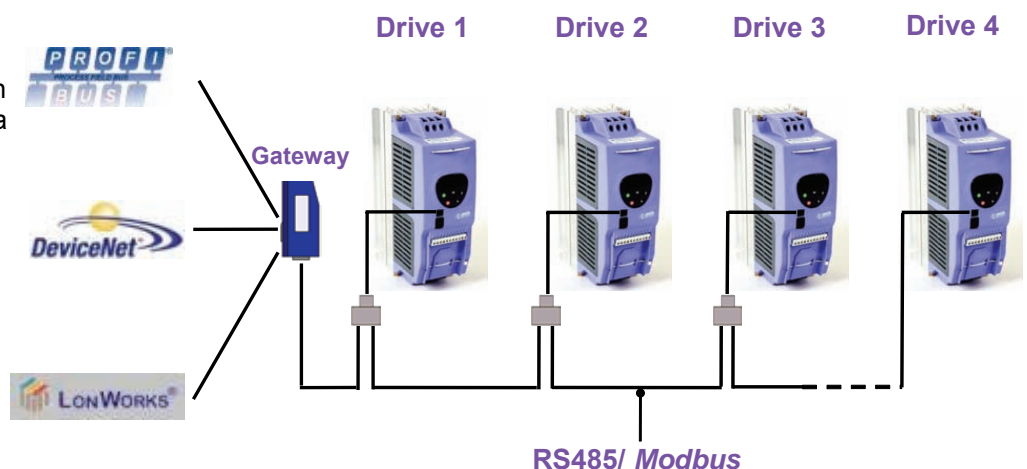

OPTIDRIVE VTC

Variable Torque Control

Dedicated to control of fans and pumps requiring standard duty

AC Variable Speed Drive 1.5 - 160kW

Optidrive VTC provides ease of use plus simple installation and commissioning, making it the lowest cost solution for virtually all variable torque applications.

Innovative and compact the Optidrive VTC range combines good looks with robustness, reliability and effortless performance.

Energy saving is maximised using the sleep mode and the automatic energy optimiser function, which reduces the motor voltage to match the load.

Coherent operation using a unified control interface across the entire range and with only 14 standard parameters to adjust, Optidrive's legendary ease of use could not be easier or quicker to get started with. For the more advanced user the extended parameter set gives access to powerful additional functionality.

OptidriveVTC's optical interface allows communication with other control equipment and also with the unique Optiwand CE Plus for fast and accurate product configuration.

Key Benefits

- True evolution of range, maintaining same footprint and connector arrangement as original
- Fast and accurate parameter configuration using unique Optiwand CE Plus and Optistore Plus
- Small mechanical envelope
- Rugged industrial operation 50°C ambient rating
- Simple mechanical & electrical installation
- Simple operation, powerful features & easy to use
- Fast setup, 14 basic parameters
- Real time motor current, motor speed and kW indication
- Debugging using troubleshooting & P0
- Standard duty 110% overload for 60 secs
- Keypad control
- Spin start
- Built in PID controller for feedback control systems
- Automatic energy optimiser
- Sleep mode
- Intelligent fire mode
- Dual high speed serial communication interfaces
 - Optical (IrDA) interface for commissioning and low bandwidth control systems (115kbps)
 - RS485/ Modbus RTU interface for high bandwidth control (9k6 to 115kbps)



Key Physical Features

- Pluggable control terminals
- Easy access key slots for simple installation
- Easy access contactor style power terminals for intuitive easy wiring
- Help card for basic parameter description and terminal layout
- Easy to use keypad with bright LED display
- IP20
- Integral rfi filter
- Integral braking transistor
- 3 phase line choke (size 4, 5 & 6)

Key Control I/O Features

- Programmable I/O for flexible control
- 12 bit bipolar analogue input, 8ms sample time
- 2nd analogue input for PID feedback control systems
- Positive logic digital inputs (active high), 8ms sampling
- 24V/ 100mA user supply output
- 0..10V & 4..20mA analog output, 8ms update
- Galvanically isolated and short circuit proof

Key Programming Features

- Silent motor running with 32kHz ultra-quiet switching
- 8 preset speeds
- Mains dip ride through
- Skip frequency
- Last 4 trips stored
- 120Hz output frequency
- Parameter lock
- Hours run & kWh meters
- Speed scaling factor for master- slave arrangements
- 2nd deceleration ramp for rapid stop
- Display scaling to show real values ie "temperature"



ELECTRICAL DATA

OPTIDRIVE VTC SIZE 2

Model	ODV-xxxxx-IN	22150	22220	24150	24220	24400
Motor output rating	kW	1.5	2.2	1.5	2.2	4
Model	ODV-xxxxx-USA	22020	22030	24020	24030	24050
Motor output rating	HP	2.0	3.0	2.0	3.0	5.0
Supply voltage/ phases	V +/- 10%	220-240/ 1Ø		380-480/ 3Ø		
Supply fuse or MCB rating	A	20	30	10	10	20
Output voltage/ phases	V	0-240/ 3Ø		0-480/ 3Ø		
Output current – 110% overload	A	7	10.5	4.1	5.8	9.5
Max motor cable length	m	100				
Min brake resistor	Ω	33	22	47	47	33

OPTIDRIVE VTC SIZE 3

Model	ODV-xxxxx-IN	32030	32040	32055	34055	34075	34110	34150
Motor output rating	kW	3.0	4.0	5.5	5.5	7.5	11.0	15.0
Model	ODV-xxxxx-USA	32040	32050	32075	34075	34100	34150	34200
Motor output rating	HP	4	5	7.5	7.5	10.0	15.0	20.0
Supply voltage/ phases	V +/- 10%	220-240/ 1 (50% derating) or 3Ø			380-480/ 3Ø			
Supply fuse or MCB rating	A	32	32	50	32	32	50	50
Output voltage/ phases	V	0-240/ 3Ø			0-480/ 3Ø			
Output Amps – 110% overload	A	14	18	25	14	18	25	30
Max motor cable length	m	100						
Min brake resistor	Ω	15			22			

OPTIDRIVE VTC SIZE 4

Model	ODV-xxxxx-IN	42075	42110	42150	42185	42220
Motor output rating	kW	7.5	11	15	18.5	22
Model	ODV-xxxxx-USA	42100	42150	42200	42250	42300
Motor output rating	HP	10	15	20	25	30
Supply voltage/ phases	V +/- 10%	220-240/ 1 (50% derating) or 3Ø				
Supply fuse or MCB rating	A	80	80-100	100	100-125	160
Output voltage/ phases	V	0-240/ 3Ø				
Output Amps – 110% overload	A	39	46	61	72	90
Max motor cable length	m	100				
Min brake resistor	Ω	6				

Model	ODV-xxxxx-IN	44185	44220	44300	44370	44450
Motor output rating	kW	18.5	22	30	37	45
Model	ODV-xxxxx-USA	44250	44300	44400	44500	44600
Motor output rating	HP	25	30	40	50	60
Supply voltage/ phases	V +/- 10%	380-480/ 3Ø				
Supply fuse or MCB rating	A	80	80-100	100	100-125	160
Output voltage/ phases	V	0-480/ 3Ø				
Output Amps – 110% overload	A	39	46	61	72	90
Max motor cable length	m	100				
Min brake resistor	Ω	12				

OPTIDRIVE VTC SIZE 5

Model	ODV-xxxxx-IN	52300	52370	52450	54550	54750	54900
Motor output rating	kW	30	37	45	55	75	90
Model	ODV-xxxxx-USA	52400	52500	52600	54750	54100	54120
Motor output rating	HP	40	50	60	75	100	120
Supply voltage/ phases	V +/- 10%	220-240/ 1 (50% derating) or 3Ø			380-480/ 3Ø		
Supply fuse or MCB rating	A	200	250-300	250-300	200	250-300	250-300
Output voltage/ phases	V	0-240/ 3Ø			0-480/ 3Ø		
Output Amps – 110% overload	A	110	150	180	110	150	180
Max motor cable length	m	100					
Min brake resistor	Ω	3			6		

OPTIDRIVE VTC SIZE 6 (EXTERNAL 3 PHASE LINE CHOKE)

Model	ODV-xxxxx-IN	64110	64132	64160
Motor output rating	kW	110	132	160
Model	ODV-xxxxx-USA	64150	64175	64210
Motor output rating	HP	150	175	250
Supply voltage/ phases	V +/- 10%	380-480/ 3Ø		
Supply fuse or MCB rating	A	315	350	400
Output voltage/ phases	V	0-480/ 3Ø		
Output Amps - 110% overload	A	202	240	300
Max motor cable length	m	100		
Min brake resistor	Ω	6		

SPECIFICATION

- Supply frequency 48 to 62 Hz
- Max. permissible 3-phase supply imbalance 3%
- Max. ambient temperature 50 °C
- Max. altitude 2000 m
- Derate above 1000 m, 1% / 100 m
- For higher switching frequencies, derate output current 5%/°C above max. ambient up to 50°C
- I x t protection above 100% output current
- 110% overload protection for 60 sec
- 125% overload allowable for 2 sec
- Storage temperature -40 to +60 °C
- Options:
 - Optiwand CE Plus & Optistore Plus
 - Optiport Plus
 - RS485 data cables and accessories
 - Optilink
 - Gateway options
 - 3ROUT (3 Relay Output)
 - Isolated USB to RS485 adaptor
 - Optifilter
 - Optibrake
 - Input Chokes
 - Output Filters

CONTROL TERMINAL ARRANGEMENT

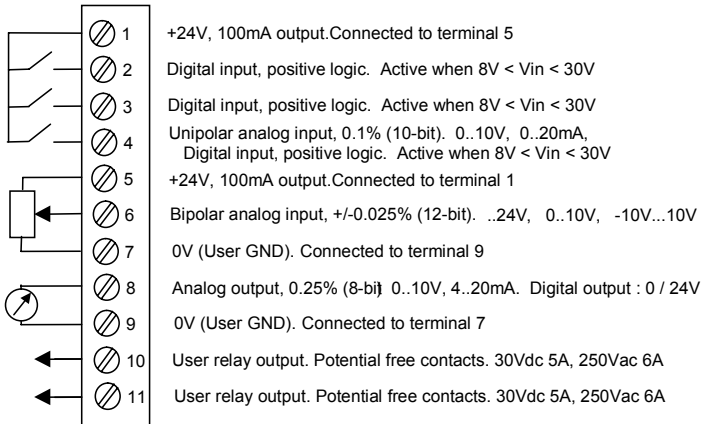

COMMUNICATION INTERFACE

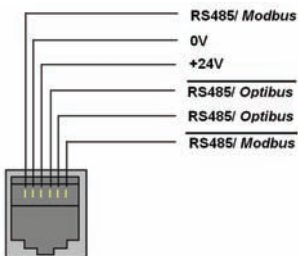

OPTIDRIVE DIMENSIONS

	Size 2	Size 3	Size 4	Size 5 *	Size 5**	Size 6
Length / mm	260	260	520	1045	1100	1100
Width / mm	100	171	340	340	340	340
Depth / mm	175	175	220	220	330	330
Weight/ kg	2.6	5.3	28	67	68	55 ***
Fixings	2 * M4	4 * M4	4 * M8			
Power Terminal torque settings	1 Nm		4 Nm	8 Nm		

- * Size 5 – 90A and 110A ratings
- ** Size 5 – 150A and 180A ratings
- *** Size 6 has external line choke weighing 27kg

ENCLOSURE - NON VENTED DIMENSIONS (mm)

DRIVE POWER RATING	SEALED UNIT		
	W	H	D
Size 2 1.5kW 200V/ 2.2kW 400V	300	400	300
Size 2 2.2kW 200V / 4kW 400V	450	600	300

ENCLOSURE – VENTED DIMENSIONS (mm)

DRIVE POWER RATING	VENTED UNIT			FORCE VENTED (WITH FAN)			
	W	H	D	W	H	D	Air Flow
Size 2 (4kW)	400	600	250	300	400	250	> 45m ³ / h
Size 3 (15kW)	600	800	300	400	600	250	> 80m ³ / h
Size 4 (22kW)	600	1000	300	600	800	300	> 300m ³ / h
Size 4 (45kW)	N/A	N/A	N/A	600	800	300	> 300m ³ / h
Size 5 (90kW)	N/A	N/A	N/A	800	1600	400	> 900m ³ / h
Size 6 (160kW)	N/A	N/A	N/A	800	2000	400	> 1000m ³ / h

Communication Interfaces



	Interface	Protocol	Baud (bps)	Purpose	Connections
RS485	RS485	Modbus RTU	9k6 – 115k	High bandwidth control systems	<ul style="list-style-type: none"> • Drive to plc • Drive to fieldbus gateway
		Optibus Plus	115k	Low bandwidth control systems	<ul style="list-style-type: none"> • Drive to pc (Optistore) • Drive to drive (unlimited slaves)
Optical	IrdA	Optibus Plus	115k	Small, low bandwidth control systems	Drive to drive (max. 2 slaves)
				Commissioning	Commissioning

Master – Slave/ Drive to Drive Communication

Master – slave networks can be easily created by connecting the communication ports. Optiwand CE Plus can be used for commissioning individual drives through the optical port even when the drives are connected in an RS485 network.

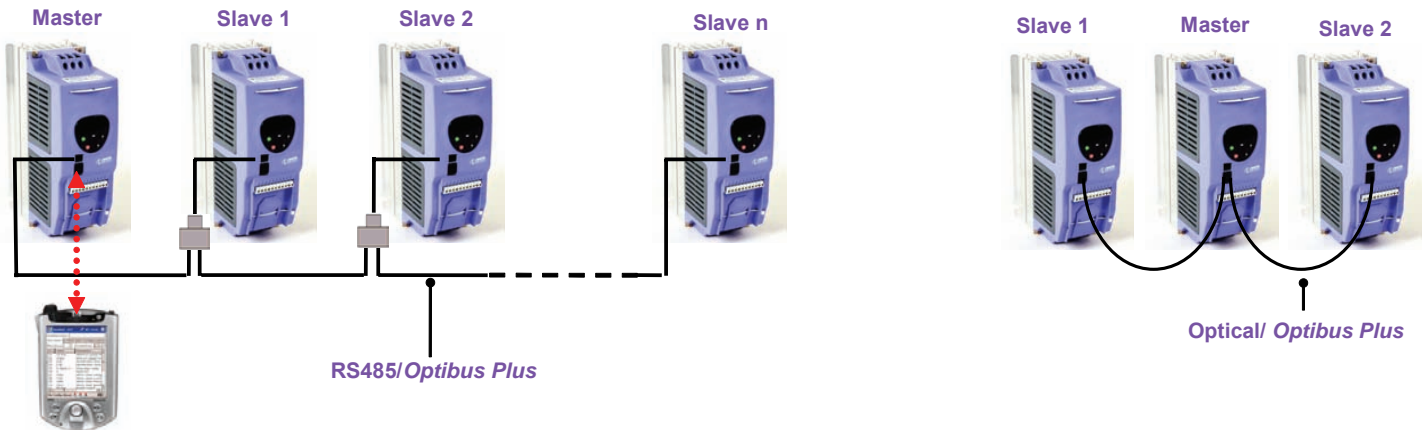

Drive Networks to Intelligent Controllers

High bandwidth control systems can be created for up to 63 drives connected to an intelligent network with RS485/ Modbus RTU. Optiport Plus and/ or Optistore Plus can run on the same network using an RS485/ Optibus Plus connection for monitoring purposes, but not for control.

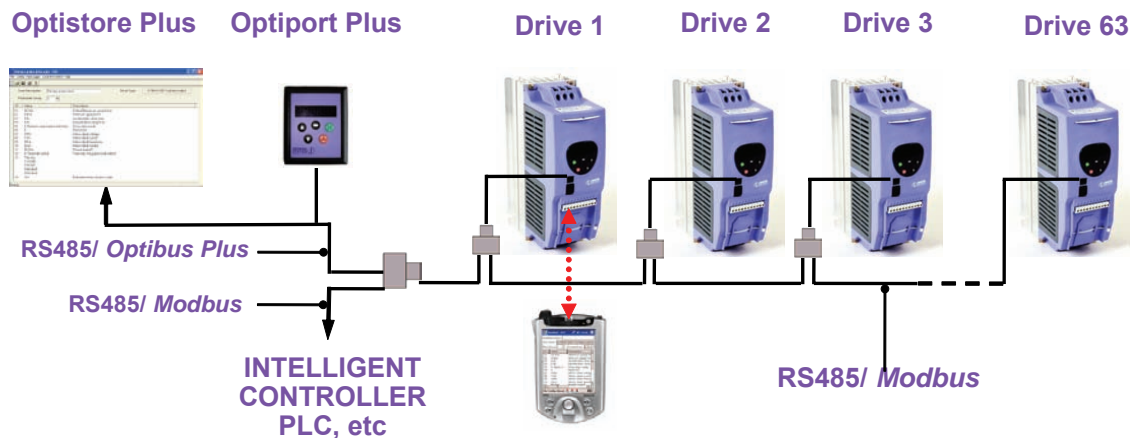

Fieldbus Communication

Optidrive Plus 3^{GV} connects to high speed communication networks via a gateway.

1 DeviceNet gateway can connect with up to 4 Optidrive.

1 Profibus gateway can connect with up to 8 Optidrive.

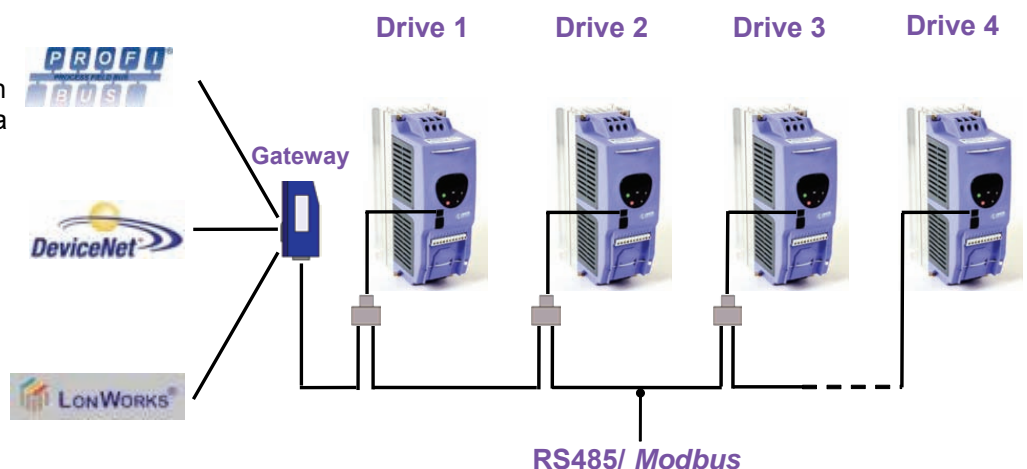

OPTIDRIVE E

Easy to use, low power, low cost

AC Variable Speed Drive 0.37- 4.0kW

Rich in features the Optidrive E is the most commercially competitive Optidrive in the Optidrive family.

Innovative and compact the Optidrive E range combines good looks with robustness, reliability and easy to use performance.

The product is dedicated to low power applications where total costs are ultra-competitive, including:

- Competitive purchase price
- Low installation costs
- Low commissioning costs
- Low technical support costs

Optidrive E has only 14 standard parameters to adjust in its basic form, thus Optidrive's legendary ease of use could not be easier or quicker to get started with.

Optidrive E can be supplied with or without an internal rfi filter.

Key Benefits

- Small mechanical envelope
- Rugged industrial 50°C ambient rating for hot and tough applications
- Simple mechanical & electrical installation
- Simple operation, powerful features easy to use
- Fast setup, factory default settings ok for most applications, only 14 basic parameters (40 max)
- Motor current and rpm indication
- Debugging using troubleshooting & P-00
- 150% overload for 60 secs (175% for 2 secs)
- Keypad control
- Integral RFI filter option



Key Physical Features

- Easy access key slots for simple installation
- Easy access contactor style power terminals for intuitive easy wiring
- Help card for basic parameter description and terminal layout
- Easy to use keypad with bright LED display
- IP20
- 5mm pitch, rising clamp control terminals

Key Control I/O Features

- Programmable I/O for flexible control
- Analogue input 12 bit resolution for accuracy
- Positive logic digital inputs (active high)
- Galvanically isolated and short circuit proof

Key Programming Features

- Silent motor running with 32kHz ultra-quiet switching
- 4 preset speeds
- "DC Injection" braking on enable to stop free wheeling motors
- Mains dip ride through
- Skip frequencies
- Last 4 trips stored
- Parameter lock
- Hours run meter
- Speed scaling factor for master- slave arrangements
- Emergency (fast) stop function



LISTED 2A00
Power Conversion Equipment
E226333

ELECTRICAL DATA

OPTIDRIVE E & EF (INTEGRAL RFI FILTER) SIZE 1

Model	ODE/ ODEF-xxxxx-IN	12037	12075	12150	14075	14150
Motor output rating	kW	0.37	0.75	1.5	0.75	1.5
Model	ODE/ ODEF-xxxxx-USA	12005	12010	12020	14010	14020
Motor output rating	HP	0.5	1.0	2.0	1.0	2.0
Supply voltage/ phases	V +/- 10%	220-240/ 1Ø			380-480/ 3Ø	
Supply fuse or MCB rating	A	10	10	20	5	10
Output voltage/ phases	V	0-240/ 3Ø			0-480/ 3Ø	
Output current	A	2.3	4.3	7.0	2.2	4.1
Max motor cable length	m	25			25	

OPTIDRIVE E & EF (INTEGRAL RFI FILTER) SIZE 2

Model	ODE/ ODEF-xxxxx-IN	22220	24220	24400
Motor output rating	kW	2.2	2.2	4
Model	ODE/ ODEF-xxxxx-USA	22030	24030	24050
Motor output rating	HP	3.0	3.0	5.0
Supply voltage/ phases	V +/- 10%	220-240/ 1Ø	380-480/ 3Ø	
Supply fuse or MCB rating	A	30	10	16
Output voltage/ phases	V +/- 10%	0-240/ 3Ø	0-480/ 3Ø	
Output current	A	10.5	5.8	9.5
Max motor cable length	m	100		

OPTIDRIVE E "VOLTAGE DOUBLER" SIZE 1 & 2 (-USA/ HP ONLY)

Model	ODE-xxxxx-USA	11005	21010	21015
Motor output rating	HP	0.5	1.0	1.5
Frame size		1	2	
Supply voltage/ phases	V +/- 10%	110-115/ 1Ø		
Supply fuse or MCB rating	A	20	20	30
Output voltage/ phases	V	0-230/ 3Ø		
Output current	A	2.3	4.3	5.8
Max motor cable length	m	25	100	

OPTIDRIVE DIMENSIONS

	Size 1	Size 2
Length / mm	155	260
Width / mm	80	100
Depth / mm	130	175
Weight/ kg	1.1	2.6
Fixings	2 * M4	
Power terminal torque settings	1 Nm	1 Nm
Control terminal torque settings	0.5 Nm	0.5 Nm

ENCLOSURE - NON VENTED DIMENSIONS (mm)

DRIVE POWER RATING	SEALED UNIT		
	W	H	D
Size 1 0.37kW 200V	200	250	200
Size 1 0.75kW 200V / 400V	250	300	200
Size 1 1.5kW 200V / 400V	300	400	250
Size 2 2.2kW 400V	300	400	300
Size 2 2.2kW 200V / 4.0kW 400V	450	600	300

ENCLOSURE - VENTED DIMENSIONS (mm)

DRIVE POWER RATING	VENTED UNIT			FORCE VENTED (WITH FAN)			
	W	H	D	W	H	D	Air Flow
Size 1 All ratings	300	400	150	200	300	150	> 15m ³ / h
Size 2 All ratings	400	600	250	200	400	250	> 45m ³ / h

Control Terminal Arrangement (default)

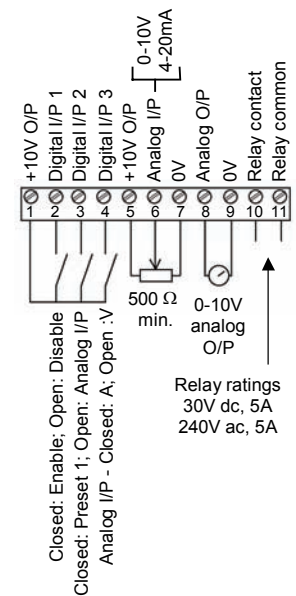

Size 2



Size 1

SPECIFICATION

- Supply frequency 48 to 62 Hz
- Max. permissible 3-phase supply imbalance 3%
- Max. ambient temperature 50 °C
- Max. altitude 2000 m
- Derate above 1000 m, 1% / 100 m
- Derate output current 5%/°C above max. ambient temp up to 50°C
- I x t protection above 100% output current
- 150% overload protection for 60 sec
- 175% overload allowable for 2 sec
- Storage temperature -40 to +60 °C
- Options:
 - Optifilter
 - Input Chokes & Output Filters
 - 2ANIN, dual analogue input
 - 2ROUT, dual relay output
 - PICON, feedback control (PI)
 - HVACO, HVAC relay output

OPTIDRIVE E1

Digital control for single phase motors

AC Variable Speed Drive 0.37-1.1kW

The Optidrive E1 is the world's first fully digital, fully packaged variable speed drive for controlling low power single phase motors.

Designed to be cost effective and easy to use, the Optidrive E1 is for use with PSC (Permanent Split Capacitor) or Shaded-Pole Single-Phase induction motors.

Optidrive E1 uses a revolutionary motor control strategy to achieve reliable intelligent starting of single phase motors.

Optidrive E1 has only 14 standard parameters to adjust in its basic form. The Optidrive's legendary ease of use ensures quick and easy drive commissioning. For the more advanced user the extended parameter set gives access to powerful additional functionality.

Key Benefits

- 115V & 220V ratings
- Single phase input/ single phase output
- Small mechanical envelope
- Rugged industrial operation 50°C ambient rating
- Simple mechanical & electrical installation
- Simple operation, powerful features & easy to use
- Fast setup, factory default settings ok for most applications, only 14 basic parameters (40 max)
- Variable torque or constant torque
- Unique programmable boost feature to achieve intelligent starting
- Motor current and rpm indication
- Debugging using troubleshooting & P-00
- 150% overload for 60 secs (175% for 2 secs)
- Keypad control



Key Physical Features

- Easy access key slots for simple installation
- Easy access contactor style power terminals for intuitive easy wiring
- Help card for basic parameter description and terminal layout
- Easy to use keypad with bright LED display
- IP20
- 5 mm pitch, rising clamp control terminals

Key Control I/O Features

- Programmable I/O for flexible control
- Analogue input 12 bit resolution for accuracy
- Positive logic digital inputs (active high)
- Galvanically isolated and short circuit proof

Key Programming Features

- Silent motor running with 32kHz ultra-quiet switching
- 4 preset speeds
- Mains dip ride through
- Skip frequencies
- Last 4 trips stored
- Parameter lock
- Hours run meter
- Speed scaling factor for master - slave arrangements
- Ten selectable V/f curves



LISTED 2A00
Power Conversion Equipment
E226333

ELECTRICAL DATA

OPTIDRIVE E1 SIZE 1

Model	ODE1-xxxxx-IN	-	12037	12075
Motor output rating	kW	-	0.37	0.75
Model	ODE1-xxxxx-USA	11050	12050	12100
Motor output rating	HP	0.5	0.5	1.0
Supply voltage/ phases	V +/- 10%	110-115/ 1Ø		220-240/ 1Ø
Supply fuse or MCB rating	A	7.0	10.0	20
Output voltage/ phases	V	0-115/ 1Ø		0-240/ 1Ø
Output current	A	4.3	4.3	7.0
Max motor cable length	m	25		

OPTIDRIVE E1 SIZE 2

Model	ODE1-xxxxx-IN	-	22110
Motor output rating	kW	-	1.1
Model	ODE1-xxxxx-USA	21075	22150
Motor output rating	HP	0.75	1.5
Supply voltage/ phases	V +/- 10%	110-115/ 1Ø	
Supply fuse or MCB rating	A	20	20
Output voltage/ phases	V +/- 10%	0-115/ 1Ø	
Output current	A	10.5	10.5
Max motor cable length	m	100	

OPTIDRIVE DIMENSIONS (mm)

	Size 1	Size 2
Length	155	260
Width	80	100
Depth	130	175
Weight (kg)	1.1	2.6
Fixings	2 * M4	
Power terminal torque settings	1 Nm	1 Nm

ENCLOSURE - NON VENTED DIMENSIONS (mm)

DRIVE RATING	SEALED UNIT		
	W	H	D
Size 1 All ratings	300	400	200
Size 2 All ratings	450	600	300

ENCLOSURE - VENTED DIMENSIONS (mm)

DRIVE RATING	VENTED UNIT			FORCE VENTED/ WITH FAN			
	W	H	D	W	H	D	Air Flow
Size 1 All ratings	300	400	150	200	300	150	>15m ³ /h
Size 2 All ratings	400	600	250	300	400	250	>45m ³ /h

SPECIAL BOOST PHASE OPERATION

To ensure reliable starting, the Optidrive E1 initially ramps the motor voltage up to rated frequency and voltage, before reducing the frequency and voltage to the desired operating point, see diagrams below.

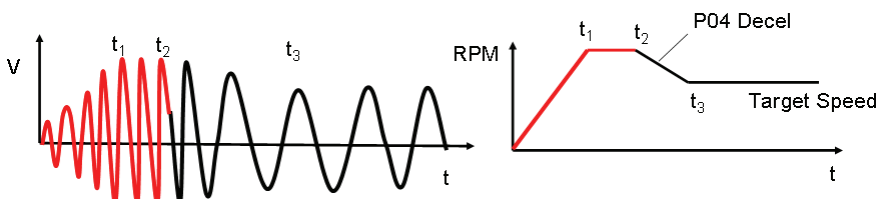

SPECIFICATION

- Supply frequency 48 to 62 Hz
- Max. ambient temperature 50°C
- Max. altitude 2000 m
- Derate above 1000 m, 1% / 100 m
- Derate output current 5%/°C above max. ambient temp up to 50°C
- I x t protection above 100% output current
- 150% overload protection for 60 sec
- 175% overload allowable for 2 sec
- Storage temperature -40 to +60°C
- Options:
 - Optifilter
 - Input Chokes & Output Filters
 - 2ANIN, dual analogue input
 - 2ROUT, dual relay output
 - PICON, feedback control (PI)
 - HVACO, HVAC relay output

Control Terminal Arrangement (default)

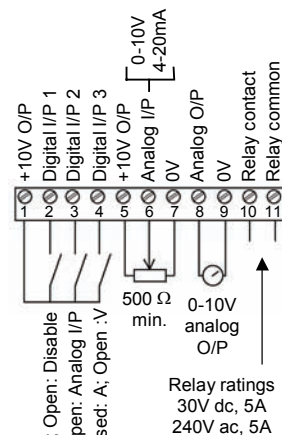

Size 2



ENCLOSED OPTIDRIVE IP55 / NEMA 12

Easy to use, low power, low cost
AC Variable Speed Drive 0.37- 4.0kW

The ultimate drive for harsh environments. The IP55 / NEMA 12 enclosure drive has been designed to expand the success of the Optidrive E and Optidrive Plus 3^{GV} product ranges.

Available in switched or non-switched enclosures.

Switched Units

- Local Power Isolator
- Local Potentiometer for speed control
- Drive Fwd/Rev switch

Key Benefits

- Wash down duty IP55/NEMA 12
- Wall mountable
- Resists low-pressure water, dust, dirt and chemicals
- Rugged industrial 40°C ambient rating for hot and tough applications
- Conduit cable entry
- Switched or non switched
- Infra red capability
- Keypad Control
- Integral RFI filter option
- Small mechanical size

Industry Sectors

- Food processing
- Bottling
- Pumping
- Chemical
- Waste Water
- HVAC



UL Pending



ELECTRICAL DATA

OPTIDRIVE E & EF (INTEGRAL RFI FILTER) SIZE 1 (-I55 Unswitched, -I55S Switched)

Model	ODE/ ODEF-xxxxx-IN-I55 ODE/ ODEF-xxxxx-IN-I55S	12037	12075	12150	14075	14150
Motor output rating	kW	0.37	0.75	1.5	0.75	1.5
Model	ODE/ ODEF-xxxxx-USA-I55 ODE/ ODEF-xxxxx-USA-I55S	12005	12010	12020	14010	14020
Motor output rating	HP	0.5	1.0	2.0	1.0	2.0
Supply voltage/ phases	V +/- 10%	220-240/ 1Ø			380-480/ 3Ø	
Supply fuse or MCB rating	A	10	10	20	5	10
Output voltage/ phases	V	0-240/ 3Ø			0-480/ 3Ø	
Output current	A	2.3	4.3	7.0	2.2	4.1
Max motor cable length	m	25			25	

OPTIDRIVE E & EF (INTEGRAL RFI FILTER) SIZE 2 (-I55 Unswitched, -I55S Switched)

Model	ODE/ ODEF-xxxxx-IN-I55 ODE/ ODEF-xxxxx-IN-I55S	22220	24220	24400
Motor output rating	kW	2.2	2.2	4
Model	ODE/ ODEF-xxxxx-USA-I55 ODE/ ODEF-xxxxx-USA-I55S	22030	24030	24050
Motor output rating	HP	3.0	3.0	5.0
Supply voltage/ phases	V +/- 10%	220-240/ 1Ø	380-480/ 3Ø	
Supply fuse or MCB rating	A	30	10	16
Output voltage/ phases	V +/- 10%	0-240/ 3Ø		0-480/ 3Ø
Output current	A	10.5	5.8	9.5
Max motor cable length	m	100		

Size 1
Non-switched



Size 1
Switched



OPTIDRIVE PLUS 3^{GV} SIZE 1 (-I55 Unswitched, -I55S Switched)

Model	ODP -xxxxx-IN-I55 ODP -xxxxx-IN-I55S	12037	12075	12150
Motor output rating	kW	0.37	0.75	1.5
Model	ODP -xxxxx-USA-I55 ODP -xxxxx-USA-I55S	12005	12010	12020
Motor output rating	HP	0.5	1.0	2.0
Supply voltage/ phases	V +/- 10%	220-240/ 1Ø		
Supply fuse or MCB rating	A	6-10	10	20
Output voltage/ phases	V	0-240V/ 3Ø		
Output current	A	2.3	4.3	7.0
Max motor cable length	m	25		

OPTIDRIVE PLUS 3^{GV} SIZE 2 (-I55 Unswitched, -I55S Switched)

Model	ODP -xxxxx-IN-I55 ODP -xxxxx-IN-I55S	22150	22220	24075	24150	24220	24400
Motor output rating	kW	1.5	2.2	0.75	1.5	2.2	4
Model	ODP -xxxxx-USA-I55 ODP -xxxxx-USA-I55S	22020	22030	24010	24020	24030	24050
Motor output rating	HP	2.0	3.0	1.0	2.0	3.0	5.0
Supply voltage/ phases	V +/- 10%	220-240/ 1Ø			380-480/ 3Ø		
Supply fuse or MCB rating	A	20	30	6-10	10	10	20
Output voltage/ phases	V	0-240/ 3Ø			0-480/ 3Ø		
Output current	A	7	10.5	2.2	4.1	5.8	9.5
Max motor cable length	m	100	100	50	100	100	100
Min brake resistor	Ω	33	22	47	47	47	33

OPTIDRIVE DIMENSIONS

	Size 1	Size 2
Length / mm	200	310
Width / mm	140	164.8
Depth / mm	162	176
Fixings	2 * M4	4 * M4
Power terminal torque settings	1 Nm	
Control terminal torque settings	0.5 Nm	



Dynamic Braking Resistor

- Available for Optidrive Plus Size 2
- Mounts into the rear of the heatsink
- 100R, 200W continuous
- Part Number: OD-BR100-I55

OPTIDRIVE COOLPATE

Easy To Use Ultimate Performance

AC Variable Speed Drive 0.37- 4.0kW

Optidrive Coolplate has been designed for OEM applications where space is a restriction.

The drive comes part ready for integrating into your installation. Mounting of the heatsink externally simplifies heat dissipation.

Key Benefits

- Available for the all of Optidrive Product Range for Sizes 1 & 2
- Slim design for cubicle mounting
- No cooling fan
- Infrared capability
- Keypad Control
- Integral RFI filter option
- Small mechanical size
- IP20 rating

Industry Sectors

- Textiles
- Packaging/packing
- Materials handling
- Special machines

Part Numbers

Coolplate drives are defined by a "C" when ordering

- Optidrive E - ODEC-xxxxx-IN
- Optidrive EF - ODEFc-xxxxx-IN (with RFI filter)
- Optidrive Plus 3^{GV} - ODPC-xxxxx-IN
- Optidrive VTC - ODVC-xxxxx-IN



OPTIDRIVE COOLPATE DIMENSIONS

	Size 1	Size 2
Length / mm	175	282
Width / mm	70	102
Depth / mm	97	115
Fixings	2 * M4	4 * M4
Power terminal torque settings	1 Nm	
Control terminal torque settings	0.5 Nm	

Size 2

Size 1



OPTIPOINT PLUS

Remote keypad and display

Optiport Plus is an intelligent device with its own microcontroller, which connects to either a single Optidrive Plus 3^{GV} or VTC or a network of Optidrives using an electrical interface.

Optiport Plus behaves as the remote keypad and display for the Optidrive on the network which has the same serial address. The physical layout and the operation of the Optiport Plus keypad and display mimic the Optidrive exactly.

Key Benefits

- Real time keypad and display operation mimics Optidrive
- Single electrical interface for power and data
- Communicates with any single drive across a network
- Connects automatically to any Optidrive Plus 3^{GV} or VTC
- IP54 rating, when through panel mounted
- Connect 2 Optiports to a single drive to display speed/power/current at the same time
- Membrane keypad
- Bright LED display
- Parameter lock function available

General Specification

- Signal Interface: Standard 6-way RJ11 connector with 3m cable included
- Supply Input: 10V ... 36V DC, 30mA
- RS485 signal: industry standard 2-wire +5V differential
- Environmental: Operational 0 ... 50 °C
- Storage: -40 °C ... 60 °C
- Relative Humidity: < 95% (non condensing)
- Protection rating: IP54



Configurations

- Depending on the requirements of the application, Optiport Plus can be used in the 4 different configurations:

- One Optiport Plus with one drive



- Two Optiport Plus units with one drive

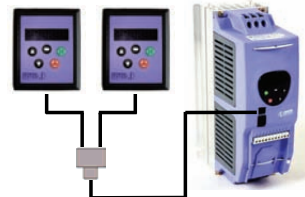

- One Optiport Plus with multiple drives

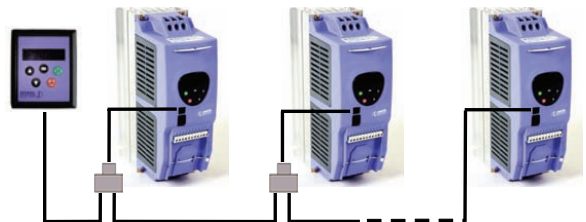

- Two Optiport Plus units with multiple drives

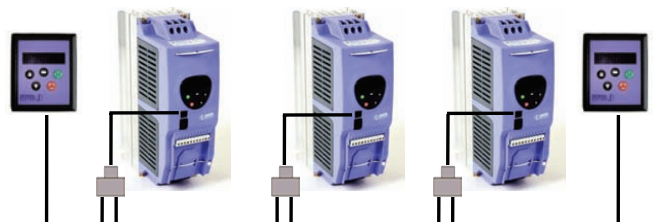

OPTIWAND CE PLUS

Unique wireless programming tool

Optiwand CE Plus is a Windows Compact Edition application program for pocket pc's, allowing quick and accurate communication with Optidrive Plus 3^{GV} & VTC for parameter management and network monitoring using infra-red optical communication.

Parameter sets are stored as files on the pocket pc and can be edited simply using the easy to use graphical interface. Full parameter descriptions facilitate programming, fast and accurate data transfer saves commissioning time and ensures commissioning accuracy. A simple configuration menu allows Optiwand CE Plus to operate in a variety of different languages.

In monitor mode, Optiwand CE Plus provides real-time feedback of drive operation displaying speed, current, power, etc. in addition to drive control features including start, stop and set speed.

Optiwand CE Plus saves time and money and improves product quality during any system or machine assembly process. It also ensures on going life-time costs are minimised as service levels are guaranteed with fast access to proven parameter settings.

The infra-red communication between the Optiwand CE Plus and Optidrive Plus 3^{GV} & VTC functions through transparent materials such as glass or perspex allowing Optidrive configuration or monitoring to take place through an appropriate enclosure window.

Key Benefits

- Fast and accurate data transfer
- Multi-language, real text parameter descriptions

Key Operating Features

- Multi-language
- On-line & off-line parameter editing
- Copy facility
- Remote Optidrive control and monitoring

Website Available

- Optiwand CE Plus is available for all Optidrive products as a free of charge download from www.invertek.co.uk



Screen parameter editing screen:

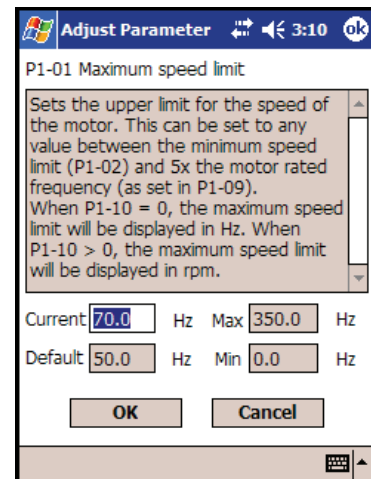

Screen showing internal parameter monitoring:

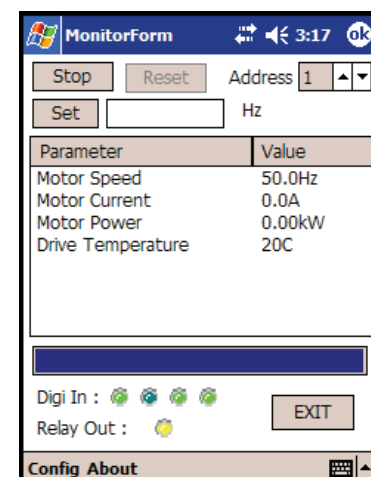

OPTISTORE PLUS

PC programming tool

Optistore is a Windows application program for pc's, allowing quick and accurate communication with Optidrive networks for parameter management and network monitoring.

Key Benefits

- Plug and go, simple and easy PC control
- Individual drive or drive network use
- PC based data storage and file management

Key Physical Features

- Connects to computer USB port
- Runs on Windows 2000 & XP

Key Operating Features

- Parameter set transfer to or from an Optiwand CE Plus
- File management: naming, storing, printing, emailing etc.
- Connects to Optidrive Plus 3GV & VTC using USB-RS485 converter cable
- For drive network management including configuration, monitoring and control
- Parameter Export facility allows the user to insert parameter settings in other programs e.g Microsoft WORD (*.rtf format)

Website Available

- Optistore is available for all Optidrive products as a free of charge download from www.invertek.co.uk

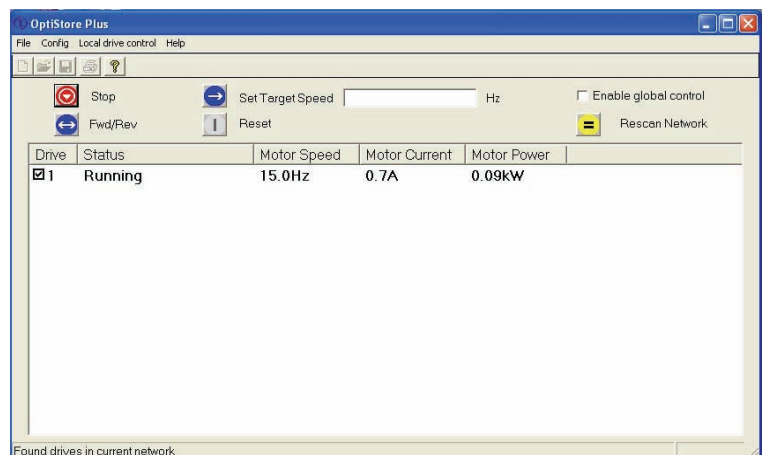
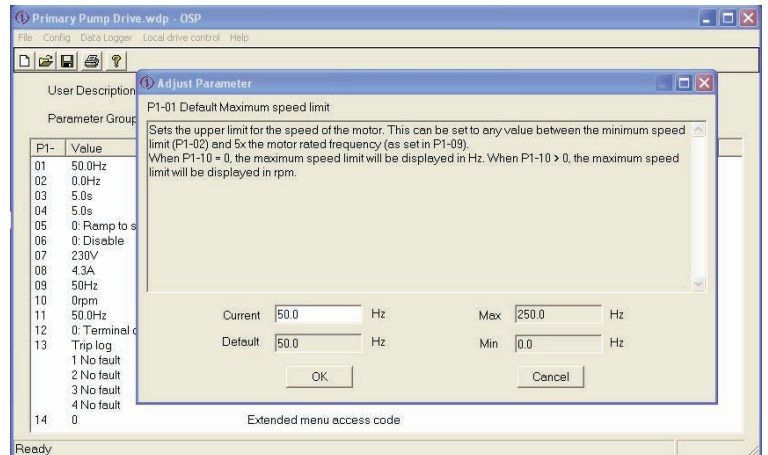
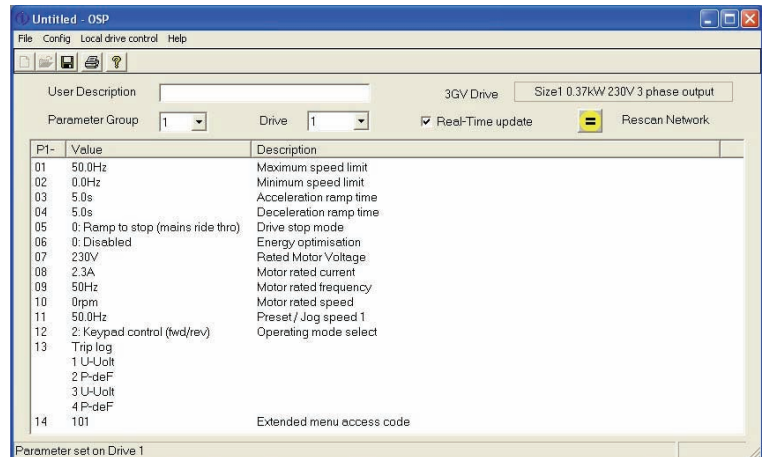

RS485 data cable splitter

RS485 data cable splitter is an RJ11 1 to 2 way connection block



Optidrive Plus 3^{GV} & Optidrive VTC Plug-in Options

3ROUT

3ROUT provides 2 additional programmable relay outputs

Specification

- Max relay switching voltage: 250V AC/ 220V DC
- Max relay switching current: 1A
- Max input voltage: +/- 50V DC
- Conformity: IP00, UL94V-0
- Environmental: -10°C ... +50°C
- Dimensions: 56 x 33 (not pins) x 14mm

New Enclosed Design

All plug-in options available for all Optidrive ranges have now been redesigned and are fully enclosed

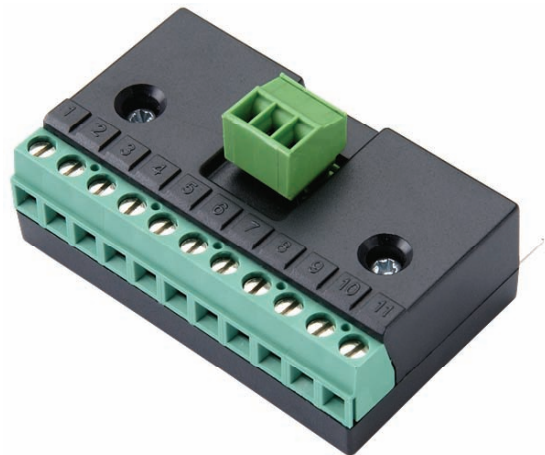

Please make
notes here.....

485AD

485AD is an isolated USB to RS485 communications adaptor designed for use with Optistore Plus.



Key Benefits

- To provide interface between PC and drive
- For use the Optistore Plus PC software
- Panel mount possibility
- Provides electrical isolation between PC and drive network

Components in the package

- USB-485 adaptor
- User and Installation guides
- Optistore Plus Installation CD
- USB cable
- DB9 – RJ11 cable
- Windows Driver CD

Configuration

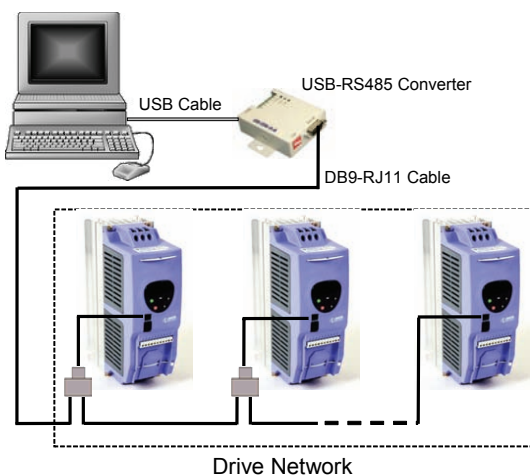

2ANIN

2ANIN allows automatic switching between 2 analogue references. Typically used for local (voltage)/ remote (current) reference switching

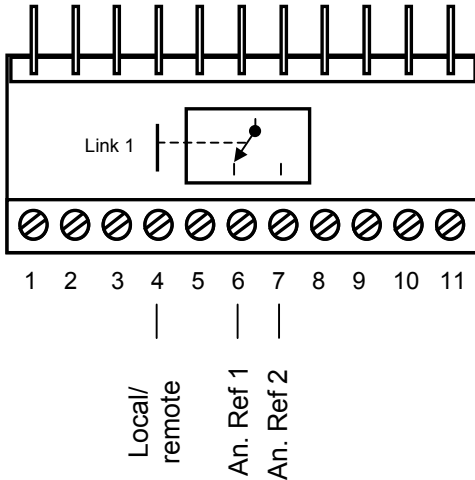

Specification

- Analogue input 1: +/- 10V DC or 4...20mA
- Analogue input 2: +/- 10V DC or 4...20mA
- Max input voltage: +/- 50V DC
- Conformity: IP00, UL94V-0
- Environmental: -10°C ... +50°C
- Dimensions: 56 x 33 (not pins) x 14mm

Optidrive E & E1 Plug-in Options

2ROUT

2ROUT provides a programmable second relay output

Programming the second relay output

The second relay output is derived from the analogue output terminal of the Optidrive and its operation is user defined by appropriate parameter settings.

Specification

- Max relay switching voltage: 250V AC/ 220V DC
- Max relay switching current: 1A
- Max input voltage: +/- 50V DC
- Conformity: IP00, UL94V-0
- Environmental: -10°C ... +50°C
- Dimensions: 56 x 33 (not pins) x 14mm

New Enclosed Design

All plug-in options available for all Optidrive ranges have now been redesigned and are fully enclosed



PICON

Low cost analogue PI controller for simple feedback control systems

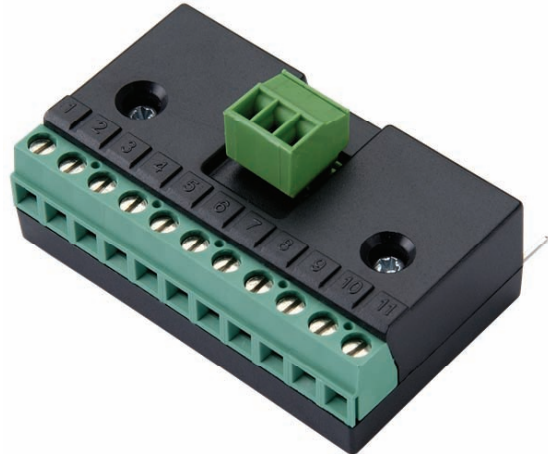
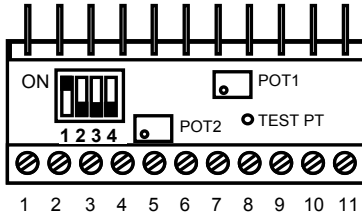

	Switch Open (OFF)	Switch Closed (ON)
S1	Integral gain 0.1s	Integral gain 1s
S2	Integral gain 0.1s	Integral gain 10s
S3	Feedback format 0..10V	Feedback format 4..20mA
S4	Reference format 0..10V	Reference format 4..20mA

Key Benefits

- Small physical size
- Potted for robustness and environmental protection
- Minimal setup for quick and easy commissioning
 - Integral gain set by 2 switches
 - Proportional gain set by potentiometer
- Built in reference potentiometer for convenient setup of feedback reference point

Specification

- Rated reference input +/- 10V DC or 4..20mA
- Proportional gain range 0.2..30
- Rated feedback input +/- 10V DC or 4..20mA
- Integral gain settings 0.1s, 1s, 10s
- Max input voltage +/- 50V DC
- Conformity IP00, UL94V-0
- Environmental -10°C .. +50°C
- Dimensions 56 x 33 (not pins) x 16mm

HVACO

HVACO provides 2 relays for typical “drive running” & “drive tripped” indicators

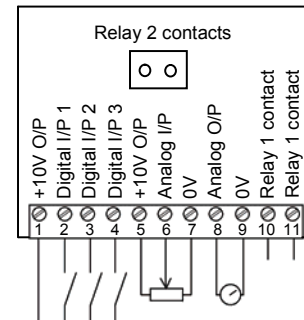

Specification

- Max relay switching voltage: 250V AC/ 220V DC
- Max relay switching current: 1A
- Max input voltage: +/- 50V DC
- Conformity: IP00, UL94V-0
- Environmental: -10°C ... +50°C
- Dimensions: 56 x 33 (not pins) x 14mm

OPTIFILTER

RFI line filters

Optidrive Size 1, 2 & 3

Footprint or side mounting filters for compliance with EMC standards for conducted emissions.

Note: all Optidrives inherently comply with the EMC radiated emission standards (EN 61000), when good wiring practice is employed.

Optifilters are mechanically easy to install and to retrofit and the provision of filter-drive cables significantly reduces electrical wiring time.

A key feature of all Optifilters is the predominant use of high specification inductive components rather than lower cost capacitive components. This substantially improves earth leakage performance and is of particular benefit for medical, domestic and multi-drive system applications where earth leakage breakers will trip less readily.

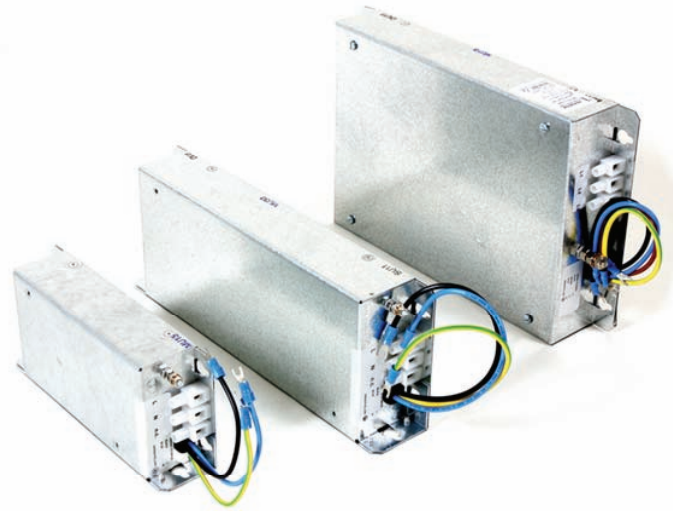

Specification

Drive Size		1	1	2	2	3
Optifilter model OD-xxxxx		F1121	F1341	F2121	F2341	F3341
Supply voltage +/- 10%	V	220-240	220-480	220-240	220-480	220-480
Phases		1	3	1	3	3
Output current max	A	16	6	25	16	30
Earth leakage	mA	<1.6	<30	<1.6	<30	<30
Dimensions						
W1	mm	90	90	114	114	186.60
W2	mm	65.50	65.50	75.50	75.50	148
W3	mm	54.50	54.50	64.50	64.50	137
W4	mm	60	60	70	70	146.60
h1	mm	200	200	300	300	300
h2	mm	30	30	20	20	20
h3	mm	5.50	5.50	5.50	5.50	6.22
h4	mm	6.50	6.50	6.50	6.50	6.50
d1	mm	175	175	225	225	225
d2	mm	46	46	51	51	51
d3	mm	23	23	25.60	25.60	-
Weight (filter only)	kg	0.5	0.5	0.9	0.9	0.9
Compliance with Conducted Emissions standards ✦						
EN 50081-1 (Domestic): motor-drive cable length						
Drive Fsw =8kHz	m	10	3	5	5	5
Drive Fsw =16kHz	m	5	3	5	5	5
Drive Fsw =32kHz	m	5	3	5	5	5
EN50081-2 (industrial): motor-drive cable length						
Drive Fsw =8kHz	m	40	10	35	35	30
Drive Fsw =16kHz	m	30	10	30	30	30
Drive Fsw =32kHz	m	25	8	25	25	25

✦ When screened cable is used and connected as per Optidrive manual employing good wiring practice

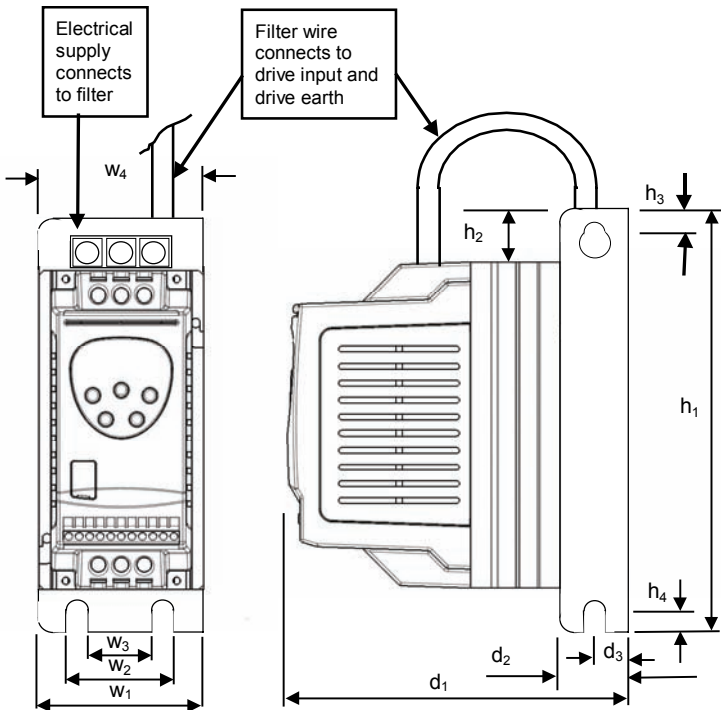

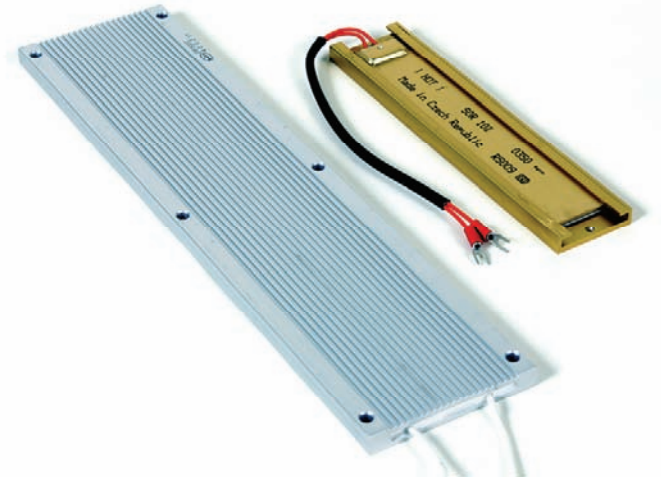

OPTIBRAKE

Dynamic braking resistors

Optidrive Size 2 to 6

Optibrake dynamic braking resistors are designed specifically for the Optidrive range. For use with high inertia loads which need to be stopped rapidly, Optibrake dynamic braking resistors assist the Optidrive manage the electrical energy returned from the motor during braking, by converting it to heat energy.

Key Benefits

- Optidrive software protects the Optibrake from overload, hence no need for expensive overload relays are required
- Internal fusible element ensures fail safe operation
- Connects to side of drive, using heatsinking properties of heatsink to prevent overheating
- No space envelope penalty, fits on side of drive
- Serial parallel arrangements for more demanding applications

Key Physical Features

- IP21, robust assembly
- Wirewound
- Metal clad housing

Specification

- Optibrake for Optidrive Size 2 and 3
 - 100 Ω , 200W continuous, 12kW peak for 0.125s
 - Dimensions 188 x 40 x 9mm
- Optibrake for Optidrive Size 4, 5 & 6
 - 33 Ω , 500Watt continuous, 21kW peak for 0.125s
 - Dimensions 330 x 80 x 12mm

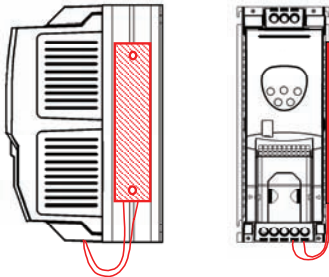

INPUT CHOKES

Reduce supply harmonic distortion and protect Optidrive against harmful supply disturbances

Most types of drive products create supply harmonic distortion owing to the configuration of the power input circuit. Input chokes are used to reduce the effects of the Optidrive upon supply harmonic distortion (see below).

Input chokes are also used to protect the power input circuits of the Optidrive against voltage spikes which might originate from lightning strikes or other equipment on the same supply. Small power Optidrives are particularly susceptible to this on certain supplies where lightning occurs or if there are other power electronic devices which cause notching on the supply ie welders, dc drives etc.

Input chokes are available for Optidrive size 1, 2 and 3.

Optidrive sizes 4, 5 & 6 include 3 phase line chokes as part of the products basic design, this significantly improves the robustness of these products and is a key specification benefit.

A range of input chokes for 12 pulse systems are available on request.

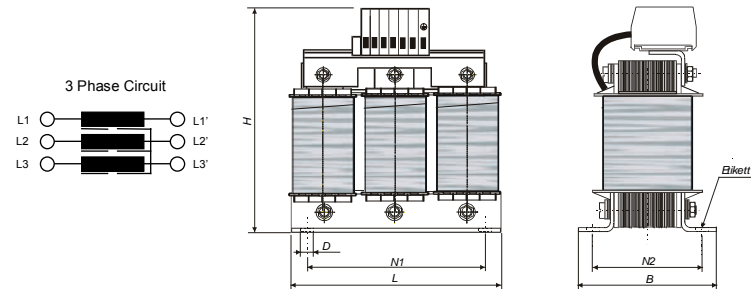
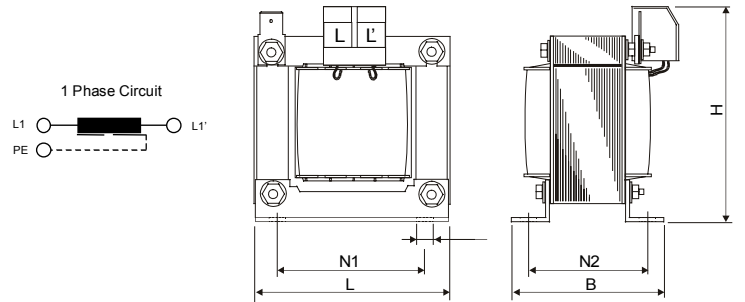
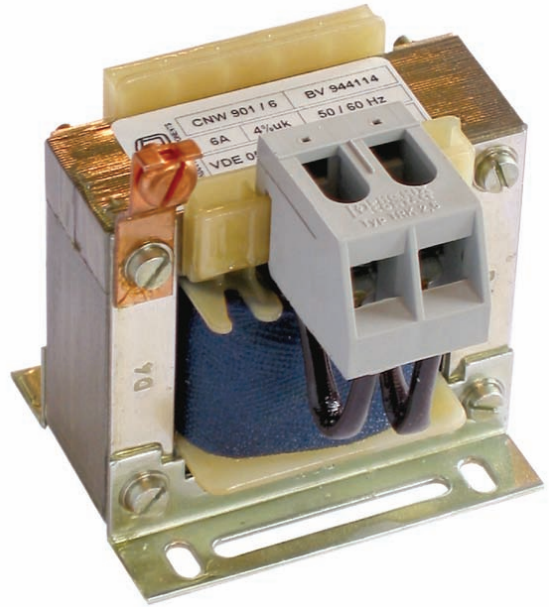

Fourier Analysis of Harmonic Distortion

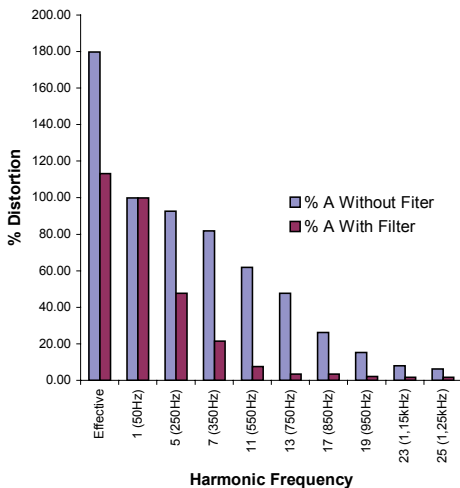

The graph shows the effect of using an input choke on typical 4kW/ 5HP drive. The 50Hz current is used as a reference and is the current which delivers the useful power to the motor. The reduction in the total effective (RMS) current is clear.

Specification

	Optidrive Size	Rated Voltage	Phase	Rated Current A	Inductance / limb mH
OD-IL121-xx	Size 1	< 230V	1	16	1.8
OD-IL221-xx	Size 2			25	1.1
OD-IL143-xx	Size 1	< 500V	3	6	4.8
OD-IL243-xx	Size 2			10	2.9
OD-IL343-xx	Size 3			36	0.81

Dimensions

	L mm	B mm	H mm	N1 mm	N2 mm	ØD mm	Mass kG
OD-IL121-xx	78	78	80	56	49	Ø4.8 x 9	1.1
OD-IL221-xx	85	95	95	64	59	Ø4.8 x 9	1.8
OD-IL143-xx	95	56	107	56	43	Ø4.8 x 9	1.3
OD-IL243-xx	125	71	127	100	55	Ø4.8 x 9	2.5
OD-IL343-xx	155	77	185	130	72	Ø8 x 12	7.2

OUTPUT FILTERS

Output filters improve the quality of the output waveform

Optidrives, like the majority of other inverter drives have unfiltered outputs. In the majority of applications this will give satisfactory performance, however, in a small number of applications output filtering is strongly recommended to improve system functionality, reliability and longevity. These applications include:

These applications include:

- Long motor cables, up to 200m
- High capacitance motor cables (ie typical "pyro" wire, used for fire protection)
- Multiple motors connected in parallel
- Motors without inverter grade insulation (typically older motors)

A range of high quality output filters are available for Optidrive with the following key features:

- Limits output voltage gradient, typically $< 200V/\mu s$
- Limits transient over voltages at the motor terminals, typically $< 1000V$
- Suppression of mains conducted interference in lower frequency ranges
- Compensation of capacitive load currents
- Reduction of rfi emissions from the motor cable
- Reduction of motor losses and audiblenoise caused by ripple

Comparison of characteristics:

Without filter

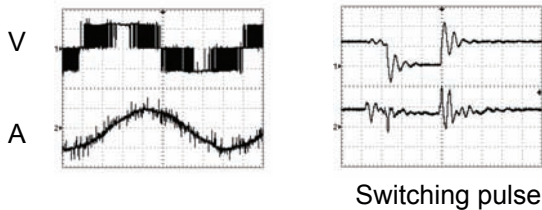

With filter

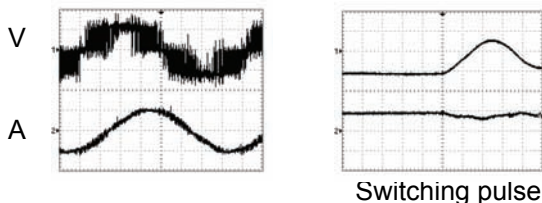

Note with filter that switching pulse rises slower and to a lower amplitude.

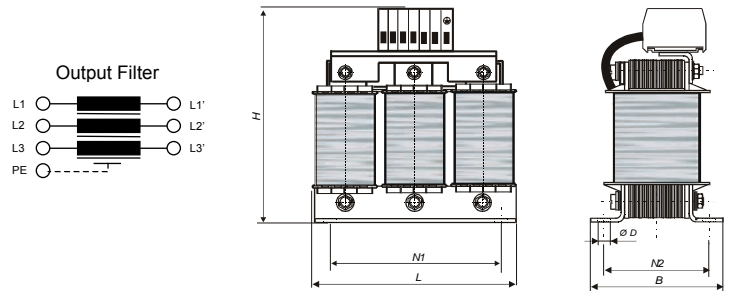
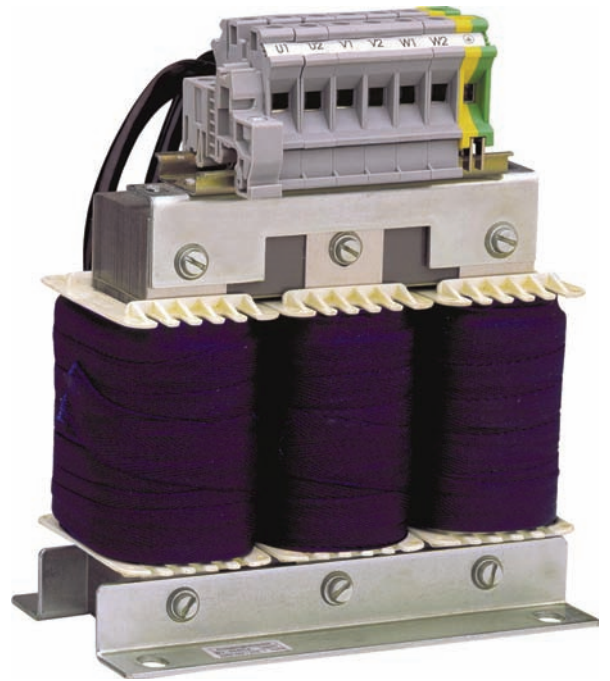

Specification

	Optidrive Size	Rated Voltage	Phase	Rated Current A	Inductance/limb mH
OD-OUTF1-xx	Size 1	< 500V	3	8	2
OD-OUTF2-xx	Size 2			12	1,3
OD-OUTF3-xx	Size 3			30	0,5
OD-OUTF4-xx	Size 4			75	0,22
OD-OUTF5-xx	Size 5			180	0,09
OD-OUTF6-xx	Size 6			250	0,065

Dimensions

	L mm	B mm	H mm	N1 mm	N2 mm	ØD mm	Mass kg
OD-OUTF1-xx	100	90	75	60	48	4	1,5
OD-OUTF2-xx	125	115	85	100	55	5	3
OD-OUTF3-xx	155	160	105	130	57	8	4,5
OD-OUTF4-xx	190	255	125	170	68	8	10
OD-OUTF5-xx	240	310	155	190	106	11	22
OD-OUTF6-xx	300	390	210	240	121	11	40



APPLICATION TIPS

Soft start

Soft starting of any application protects the mechanical drive system reducing wear and tear on bearings, belts, etc. Soft starting also reduces direct on line starting currents from 600% to 100 - 150% of motor rated current.

Motor-drive selection

The number one problem experienced by inexperienced drive users is matching the motor and drive voltage; ensure that the motor terminal box connection (star or delta) corresponds with the drive voltage.

Low speed motor operation

When an application requires a motor to run for long periods of time at low speeds, typically less than 1/3 base speed, and particularly when additional boost is applied, the motor should be force cooled.

EMC

Good cable management is the key to solving EMC problems. Always use screened cable between the drive and the motor and keep control and power cabling separated by at least 100mm. Where control and power cables must cross, ensure that they do so at 90°.

Generators

Soft starting is key in reducing generator costs as a system can be dimensioned for continuous rather than start-up operation (4 - 6 times reduction). A contactor should be placed between the generator and the drive, which should be activated by the Optidrive's drive healthy output relay. Thus, in the event of a generator over-voltage, the drive will trip causing the contactor to open removing the potentially harmful over-voltage from the drive.

Freewheeling Fans

For Optidrive E, use dc injection braking on enable to bring free-wheeling fans to rest before starting to control. Starting a drive into a free-wheeling motor creates a direct short-circuit, which damages the drive and the motor.

Variable torque (radial & axial fans)

Variable torque mode can be used to drive radial fans and pumps. Axial/ centrifugal fans or displacement pumps should be driven in constant torque mode (ie heavy duty/ 150% overload).

1 phase supplies

Optidrive offers high power single phase input, three phase output operation up to 45kW.

Energy Saving

In general, reducing the speed of a process will save energy. Using PI/ feedback control, energy saving can be maximised by running a motor at its optimum speed for a particular situation.

Variable feedrate

It is often useful to run a particular process at optimum power/ load ie a wood-saw. A first Optidrive can be used to drive the primary process and a second Optidrive can be used to control the feed of the work piece into the primary process. A PI controller uses the load output from the primary Optidrive as the feedback parameter and then changes the speed of the feed drive to keep the primary process at optimum load.

Harmonics

Drives inherently create harmonic distortion, however the effects can be significantly reduced using input line chokes. Size 4, 5 & 6 drives have integral line chokes giving rise to a significant advantage over other products which require external line chokes. 12 pulse systems can be employed to further reduce harmonic distortion.

Enclosure design

Drive system enclosure design requires a compromise between 1, managing the heat created by the drive(s) in order to keep the enclosure cool to increase component lifetime and 2, the need to seal the enclosure for environmental and safety reasons. "Through hole" mounting where the heatsink is put through a hole in the panel allows the sensitive control electronics to be totally sealed in the front of the panel, whilst the heat generating components in the rear of the panel can be kept cool with "dirty" air.

Long Cables

Ideally a drive should be placed as close as possible to the driven motor. The maximum cable length is specified in the manual, this is for armoured or screened cable. If a non screened cable is used the length can be increased by 50%. When using an output filter the cable length can be doubled.

Parallel Motors

When parallel motors are connected to a drive the extra capacitance of the parallel motors can cause problems. To rate a drive, sum the power ratings of all the motors and add 10 - 15% extra. Take care in checking the total length of the parallel motor cables does not exceed the maximum specified in the user manual – see above "Long Cables". The capacitance effect can be reduced if the motor cabling is "daisy chained" ie connected from the drive to motor 1, then motor 1 to motor 2, etc. rather than each motor being connected directly to the drive output directly.

Option Part Number Information

Part No.	Description	Comprises
Optidrive Plus 3GV and Optidrive VTC Options		
OD-OWDCE-xx	Optiwand CE Plus	Optiwand CE (software pre-installed on DELL pocket pc)
OD-OPRTP-xx	Optiport Plus, Remote Keypad	Optiport & cable OD-48530-xx
OD-48503-xx	RS485 data cable, 0.30m	Cable with RJ11 terminations at each end
OD-48510-xx	RS485 data cable, 1.0m	Cable with RJ11 terminations at each end
OD-48530-xx	RS485 data cable, 3.0m	Cable with RJ11 terminations at each end
OD-485SP-xx	RS485 data cable splitter	RS 485 splitter, 1 to 2 connection
OD-485AD-xx	Isolated RS485 to USB PC adapter kit	Isolated RS485 to USB adapter, USB cable & RJ11 cable
OD-PROFB-xx	Profibus gateway	Profibus gateway, 0.3m cable (RJ11 – 9 way D type)
OD-DEVNET-xx	DeviceNet gateway	DeviceNet gateway, 0.3m cable (RJ11 – 9 way D type)
OD-LONWKS-xx	LONworks gateway	LONworks gateway, 0.3m cable (RJ11 – 9 way D type)
ODP-3ROUT-xx	Optidrive 3 Relay Output	3ROUT interface card
Optidrive E and Optidrive E1 Options		
ODE-2ANIN-xx	Optidrive Dual Analogue Input	2ANIN interface card
ODE-2ROUT-xx	Optidrive Dual Relay Output	2ROUT interface card
ODE-PICON-xx	Optidrive PI Control Card (analogue)	PICON interface card
ODE-HVACO-xx	Optidrive HVAC Relay Output	HVAC interface card
Common Options		
OD-F1121-xx	Optifilter, Size 1, 220-240V, 1 Phase, 16A	Optifilter unit
OD-F2121-xx	Optifilter, Size 2, 220-240V, 1 Phase, 25A	Optifilter unit
OD-F1341-xx	Optifilter, Size 1, 220-480V, 3 Phase, 6A	Optifilter unit
OD-F2341-xx	Optifilter, Size 2, 220-480V, 3 Phase, 16A	Optifilter unit
OD-F3341-xx	Optifilter, Size 3, 220-480V, 3 Phase, 30A	Optifilter unit
OD-BRES2-xx	Optibrake, Size 2, 100R, 200W	Optibrake unit
OD-BRES4-xx	Optibrake, Size 4, 33R, 500W	Optibrake unit
OD-IL121-xx	Optidrive, Size 1, 220-240V, 1 Phase, 16A	Input inductor
OD-IL221-xx	Optidrive, Size 2, 220-240V, 1 Phase, 25A	Input inductor
OD-IL143-xx	Optidrive, Size 1, 380-480V, 3 Phase, 6A	Input inductor
OD-IL243-xx	Optidrive, Size 2, 380-480V, 3 Phase, 10A	Input inductor
OD-IL343-xx	Optidrive, Size 3, 380-480V, 3 Phase, 36A	Input inductor
OD-OUTF1-xx	Optidrive Output Filter, Size 1, 480V, 8.0A	Output filter
OD-OUTF2-xx	Optidrive Output Filter, Size 2, 480V, 12.0A	Output filter
OD-OUTF3-xx	Optidrive Ouput Filter, Size 3, 480V, 30.0A	Output filter
OD-OUTF4-xx	Optidrive Ouput Filter, Size 4, 480V, 75.0A	Output filter
OD-OUTF5-xx	Optidrive Ouput Filter, Size 5, 480V, 180.0A	Output filter
OD-OUTF6-xx	Optidrive Ouput Filter, Size 6, 480V, 250.0A	Output filter

NOTE: -xx is used for country/ language variation



Invertek Drives Limited
Offas Dyke Business Park
Welshpool Powys. UK
SY21 8JF

Tel: +44 (0) 1938 556868
Fax: +44 (0) 1938 556869
email: sales@invertek.co.uk
web: www.invertek.co.uk

with Invertek Drives
the revolution starts here!

All rights reserved. No part of this brochure may be reproduced or transmitted in any form or by any means, electrical or mechanical including photocopying, recording or by any other form of information storage or retrieval system without permission in writing from the publisher.

Invertek Drives Ltd adopts a policy of continuous improvement and whilst every effort has been made to provide accurate and up to date information, the information contained in this brochure should be used for guidance purposes only and does not form part of any contract.

